

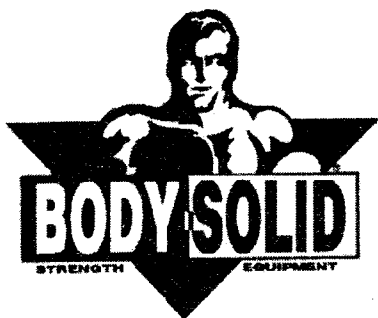

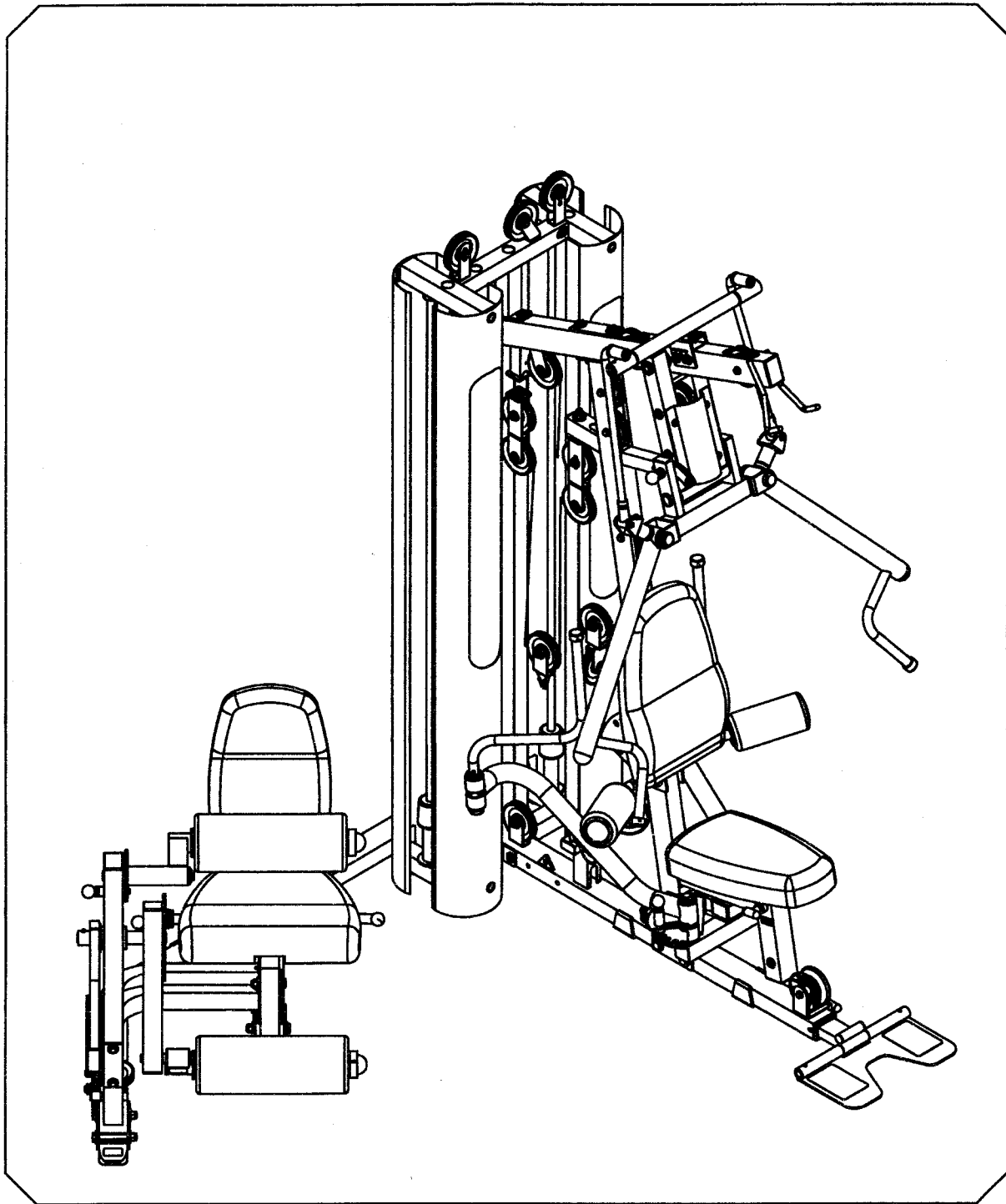





























Body-Solid



EXM-3750.1 OWNER'S MANUAL

EXM3750 ASSEMBLY INSTRUCTIONS





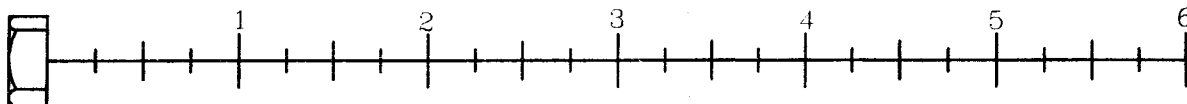
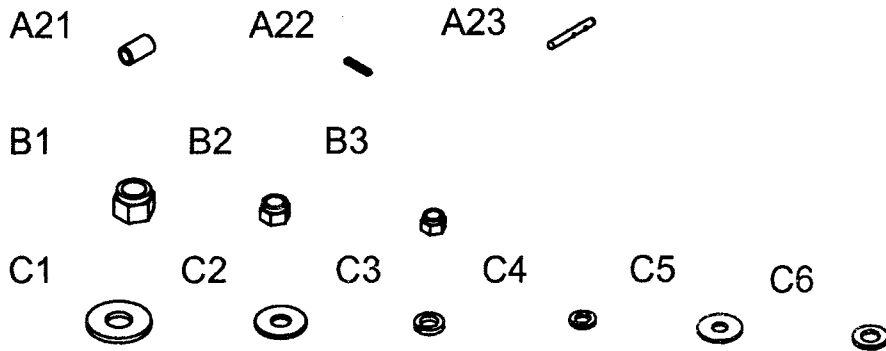











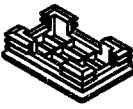



HARDWARE ILLUSTRATION

A1		A1. 1/2"X3 1/4" Hex Head Bolt-----	[6PCS]
A2		A2. 1/2"X3 1/2" Hex Head Bolt-----	[3PCS]
A3		A3. 1/2"X4" Hex Head Bolt-----	[1PCS]
A4		A4. 1/2"x4 1/4"Hex Head Bolt-----	[10PCS]
A5		A5. 3/8"X3/4" Hex Head Bolt-----	[1PCS]
A6		A6. 3/8"X1/2" Hex Head Bolt-----	[2PCS]
A7		A7. 3/8"X1" Hex Head Bolt-----	[2PCS]
A8		A8. 3/8"X1 3/4"L Hex Head Bolt -----	[15PCS]
A9		A9. 3/8"X2" Round Bolt-----	[2PCS]
A10		A10. 3/8"X2 3/4"L Hex Head Bolt -----	[5PCS]
A11		A11. 3/8"X3"L Hex Head Bolt -----	[4PCS]
A12		A12. 3/8"X3 1/2"L Hex Head Bolt -----	[1PCS]
A13		A13. 3/8"X4"L Hex Head Bolt -----	[4PCS]
A14		A14. 3/8"X7 1/4"L Hex Head Bolt -----	[2PCS]
A15		A15. 5/16"X1"L Hex Head Bolt -----	[8PCS]
A16		A16. 5/16"x1 1/4"L Hex Head Bolt-----	[4PCS]
A17		A17. 5/16"x1 1/2"L Hex Head Bolt-----	[3PCS]
A18		A18. 5/16"X2"L Hex Head Bolt -----	[2PCS]
A19		A19. M10X16L Hex Socket Button Hd Cap Screws-----	[4PCS]
A20		A20. 10LB PIN(8250-047)-----	[2PCS]
A21		A21. 1/2"x21 SLEEVE-----	[3PCS]
A22		A22. □6x45L level KEY-----	[1PCS]
A23		A23. Ø10 PIN(8250-023) -----	[1PCS]
B1		B1. 1/2" Nylon Lock Nut-----	[17PCS]
B2		B2. 3/8" Nylon Lock Nut-----	[33PCS]
B3		B3. 5/16" Nylon Lock Nut-----	[3PCS]
C1		C1. 1/2"(I.D.) Washer(Ø34)-----	[35PCS]
C2		C2. 3/8" (I.D.)Washer(Ø27)-----	[58PCS]
C3		C3. 3/8" Spring Washer-----	[2PCS]
C4		C4. 5/16" Spring Washer-----	[14PCS]
C5		C5. 5/16" (I.D.)Washer(Ø24)-----	[14PCS]
C6		C6. M10 (I.D.)Washer(Ø19)-----	[4PCS]

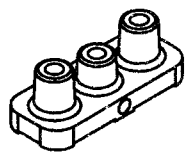
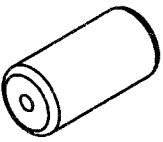

EXM3750 ASSEMBLY INSTRUCTIONS

HARDWARE ILLUSTRATION

- D1  D1. \varnothing 5/8"x22.5L Steel Bushing (8110-011)-----[4PCS]
- D2  D2. \varnothing 3/4"X8L Steel Bushing (8110-014)-----[6PCS]
- D3  D3. \varnothing 10.5 Steel Bushing (8530-009)-----[10PCS]
- D4  D4. \varnothing 8 Spring Snap Link (8810-001)-----[4PCS]
- D5  D5. 2"x2"x2.5t End Cap (9211-006)-----[6PCS]
- D6  D6. 25x50 End Cap (9211-009)-----[6PCS]
- D7  D7. 50x75 End Cap (9211-012)-----[3PCS]
- D8  D8. \varnothing 1" Round End Cap (9211-022)-----[2PCS]
- D9  D9. 50x75x2.5t Foot Cap (9211-026)-----[3PCS]
- D10  D10. \varnothing 3/4" Shaft Collar (9211-046)-----[4PCS]
- D11  D11. 50X75 Nylon Bushing (9211-056)-----[1PCS]
- D12  D12. \varnothing 50.8 Round End Cap (9211-074)-----[2PCS]
- D13  D13. 2"x3" Rubber Dount(9212-011)-----[3PCS]
- D14  D14. 2"x2" Rubber Cane Cap(9214-002)-----[4PCS]
- D15  D15. 38x38 Rubber Pad(9310-001)-----[1PCS]
- D16  D16. \varnothing 65x \varnothing 20x70L Rubber Dount(9310-049)-----[4PCS]
- D17  D17. 2"x2" Rubber Dount(9310-020)-----[1PCS]
- D18  D18. 95X140L Rubber Pad (9310-035)-----[4PCS]
- D19  D19. Top Plate(8400-005)-----[2PCS]
- D20  D20. \varnothing 4"x23x8" Foam Roller (9161-032)-----[2PCS]
- D21  D21. Weight Selector Bar (8210-070A)-----[2PCS]
- D22  D22. \varnothing 1"x2.5t Round End Cap(9260-021)-----[6PCS]

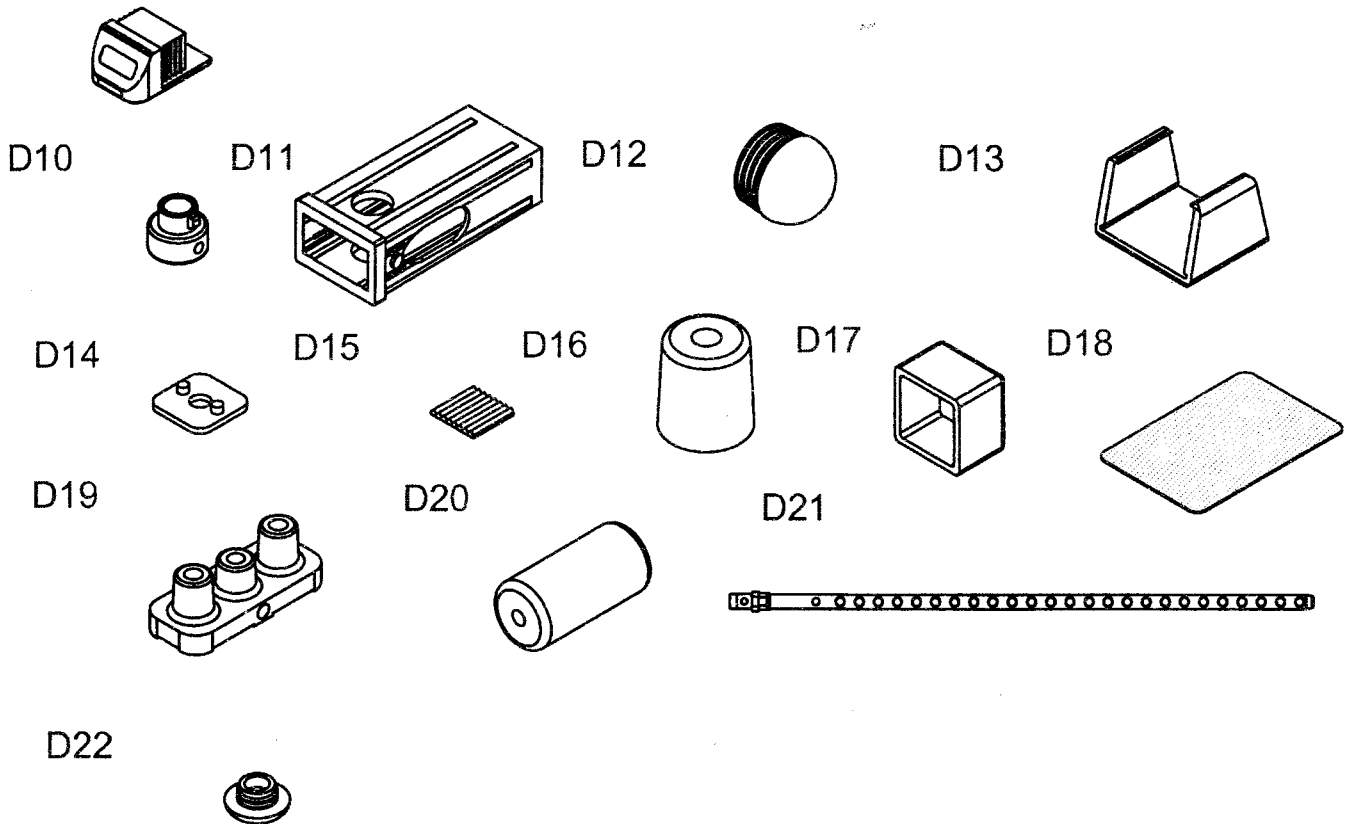

EXM3750 ASSEMBLY INSTRUCTIONS

HARDWARE ILLUSTRATION

D23.	60x45 Nylon Bushing(9211-032)	[2PCS]
D24.	Ø1"X10L Steel Bushing (8120-040)	[1PCS]
D25.	2"X2"x1.8T End Cap (9211-005)	[2PCS]
D26.	□45 End Cap (9211-004)	[1PCS]
D27.	Ø50.8x2.5t End Cap (9211-020)	[2PCS]
D28.	Ø1" End Cap (9211-016)	[2PCS]
D29.	Ø1" CU WASHER(8520-008)	[5PCS]
D30.	Ø110X22T Pully (9213-002C)	[24PCS]
D31.	Ø110X51L Pully(9213-022A)	[1PCS]
D32.	5120mm Steel Cable	[1PCS]
D33.	4705mm Steel Cable	[1PCS]
D34.	2000mm Steel Cable	[1PCS]
D35.	580mm Steel Cable	[1PCS]
D36.	5035mm Steel Cable	[1PCS]
D37.	Shoulder Belt(ACH-16)	[1PCS]
D38.	Ø10.5X13L Steel Bushing(8530-014)	[2PCS]
D38.	Steel Rope Fixed Board(9213-013)	[2PCS]

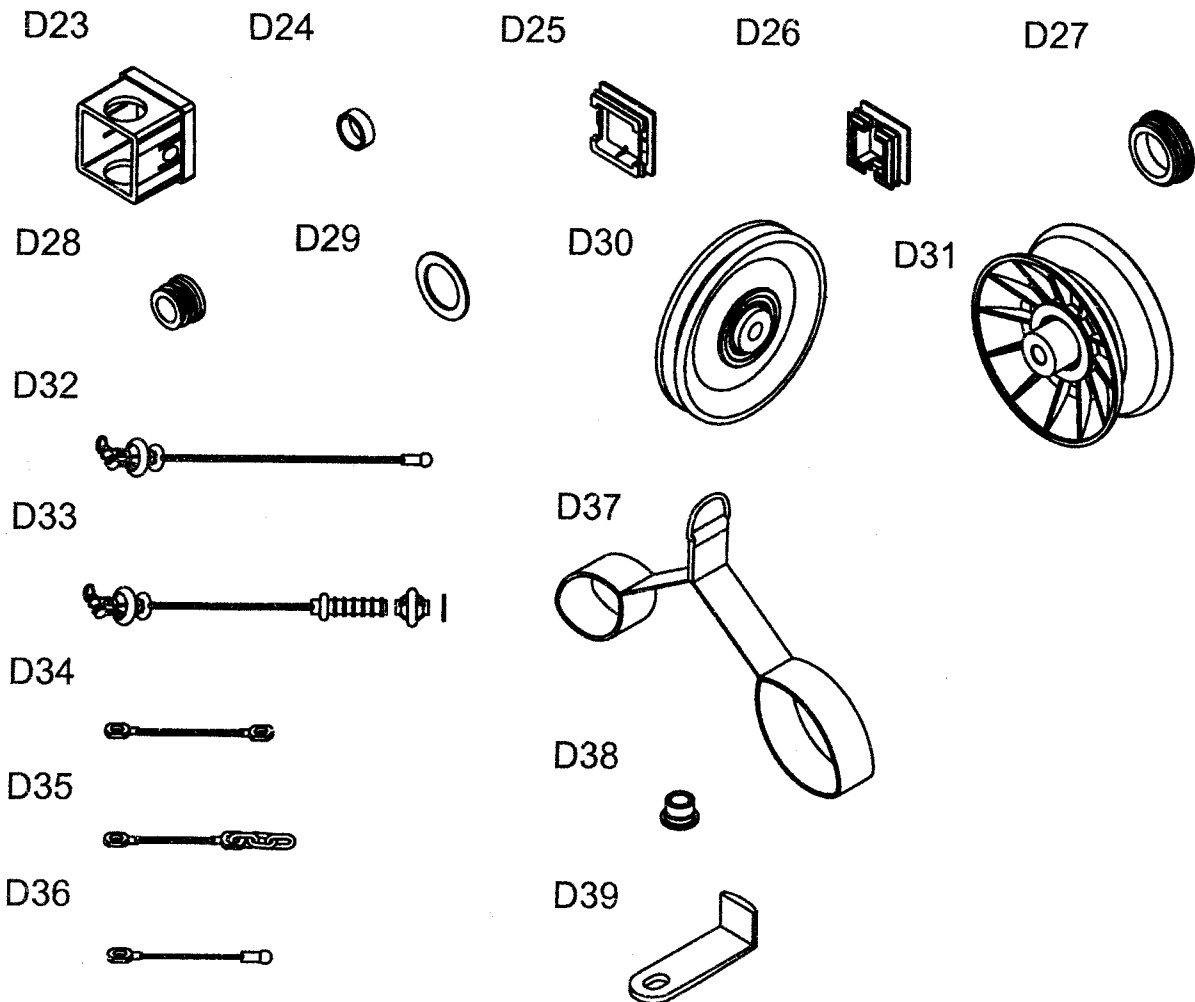

EXM3750 ASSEMBLY INSTRUCTIONS

PARTS ILLUSTRATION SHEET

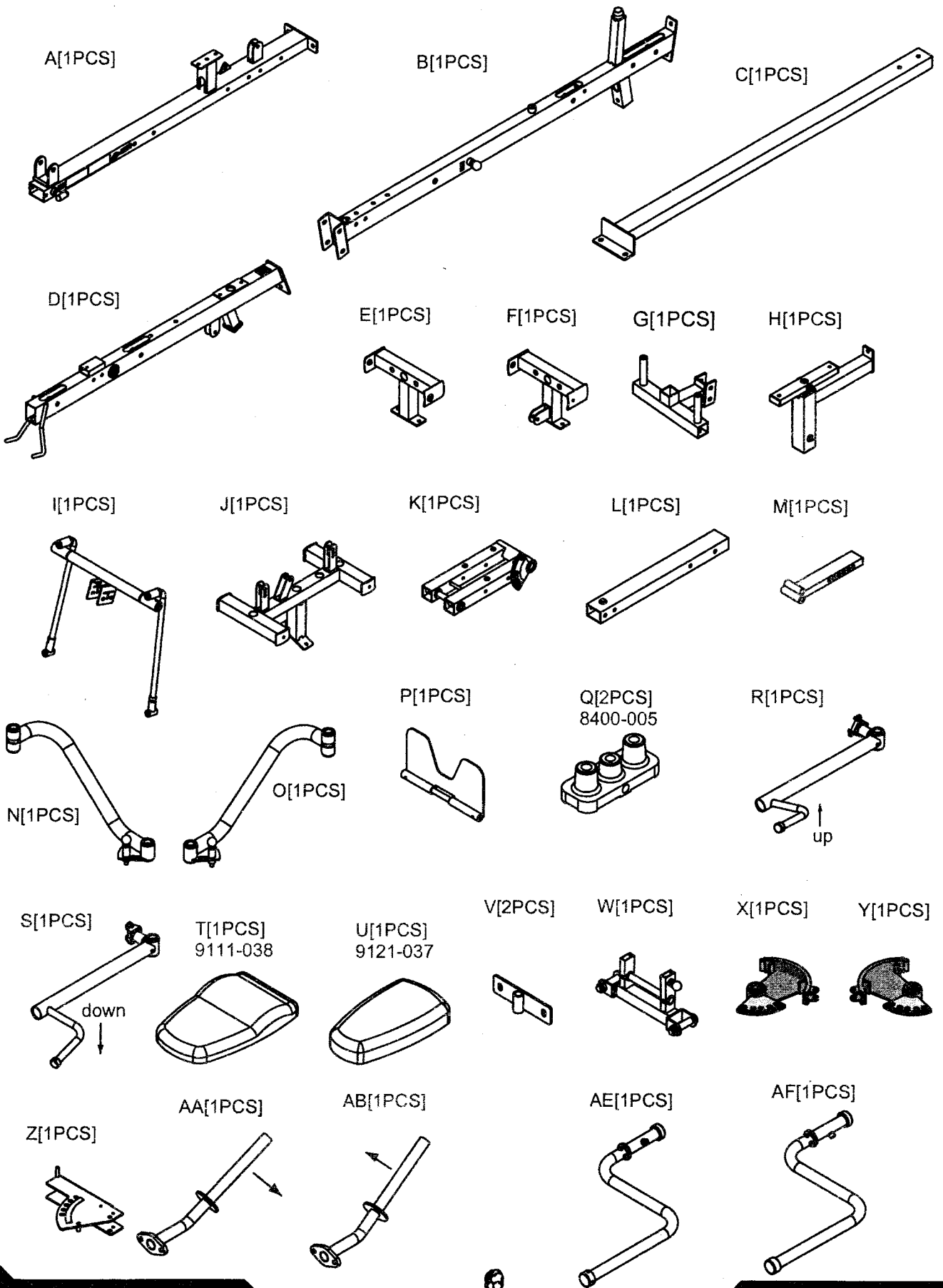

EXM3750 ASSEMBLY INSTRUCTIONS

PARTS ILLUSTRATION SHEET

AG[1PCS]



AH[1PCS]



AI[1PCS]

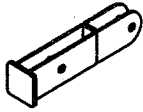

AJ[1PCS]

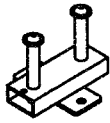

AK[2PCS]



AL[1PCS]

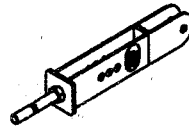

AR[1PCS]

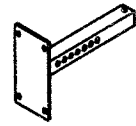

AM[1PCS]

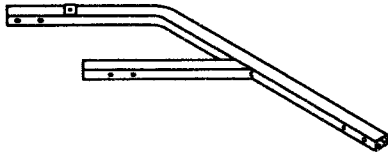

AO[1PCS]

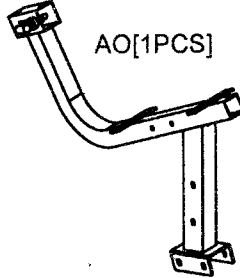

AP[1PCS]



AQ[1PCS]



AS[1PCS]

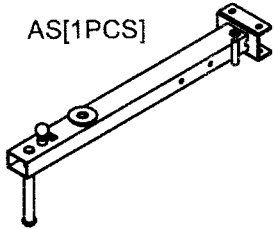

AT[1PCS]

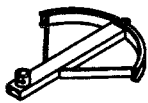

AU[1PCS]

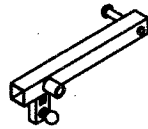

AV[1PCS]

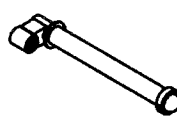

AW[1PCS]

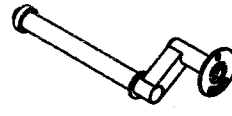

AX[1PCS]



AY[1PCS]

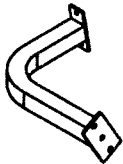

AZ[4PCS]

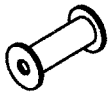

BA[1PCS]
9111-037

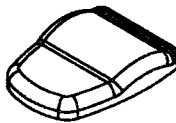

BB[1PCS]
9121-036

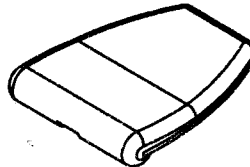

BC[2PCS]
9161-034

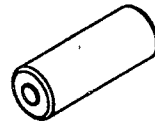

BD[1PCS]
8380-020



BE[4PCS]

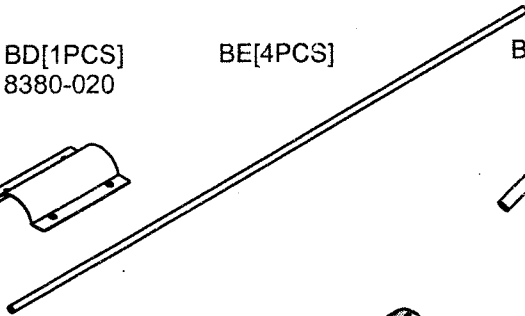

BF[1PCS]

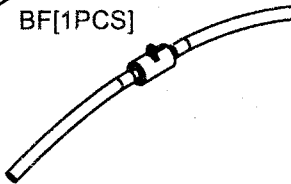

BG[1PCS]



BH[1PCS]
8380-018

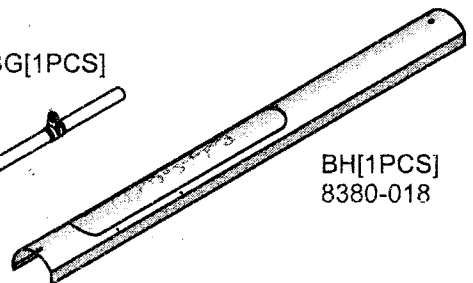

BI[1PCS]
8380-023

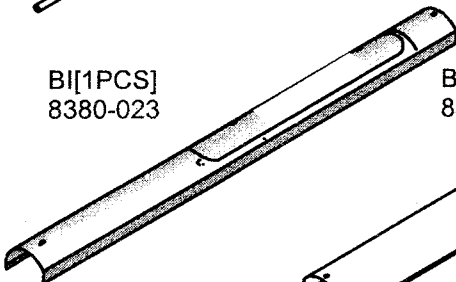

BJ[1PCS]
8380-019

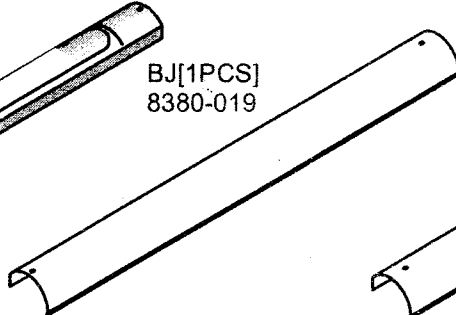

BK[1PCS]
8380-021

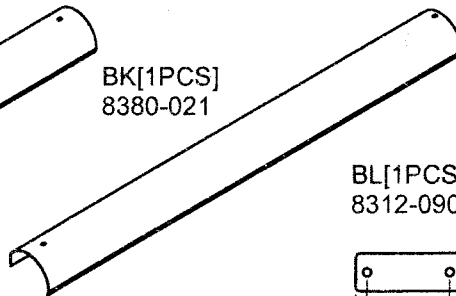

BL[1PCS]
8312-090

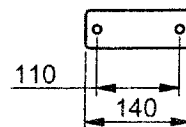

BN[1PCS]
8312-091

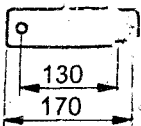

BO[1PCS]
8313-066

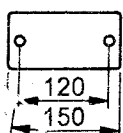

BP[1PCS]
8313-082

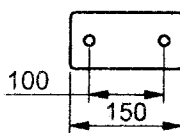

110

140