

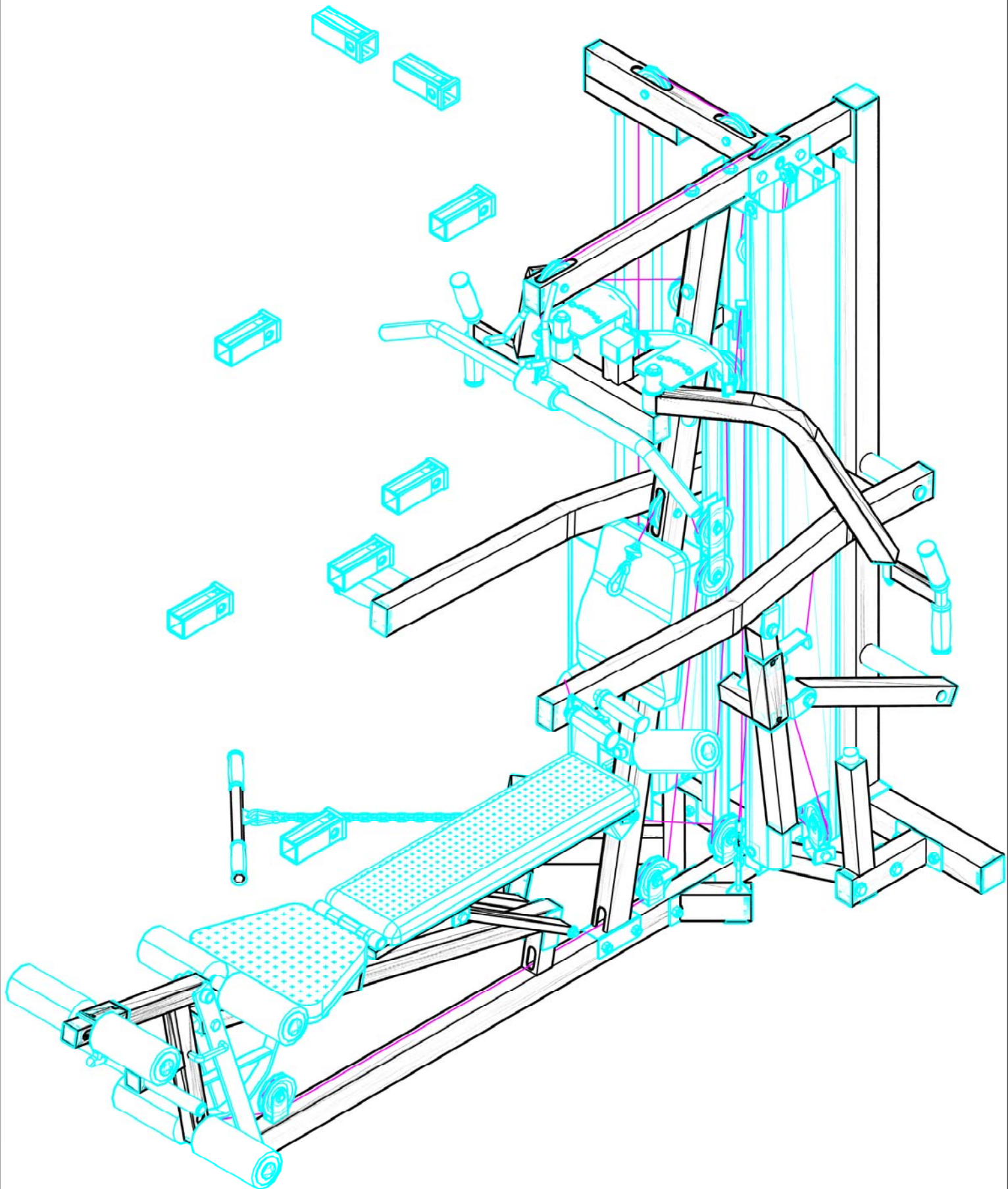

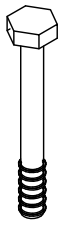







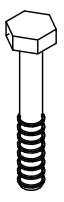













EXM-2800.2

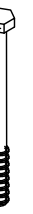
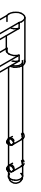

VERSION 0006

EXM-2800.2 HARDWARE ILLUSTRATION SHEET

	Qty.		Qty.		
A1. 1/2"x4" HEX HEAD BOLT -----	[12PCS]	A1 	A15 	C1 	
A2. 1/2"x3 1/4" HEX HEAD BOLT -----	[11PCS]	A2 	A9 	A16 	C2 
A3. 1/2"x3" HEX HEAD BOLT -----	[6PCS]	A3 	A10 	B1 	C3 
A4. 3/8"x2 3/4" HEX HEAD BOLT -----	[5PCS]	A4 	A11 	B2 	C4 
A5. 3/8"x1 3/4" HEX HEAD BOLT -----	[5PCS]	A5 	A12 	B3 	C5 
A6. 3/8"x1 1/2" HEX HEAD BOLT -----	[10PCS]	A6 	A13 	B4 	C6 
A7. 5/16"x4" HEX HEAD BOLT -----	[2PCS]	A7 	A14 	B5 	
A8. 5/16"x1 3/4" HEX HEAD BOLT -----	[2PCS]				
A9. 5/16"x1 1/2" HEX HEAD BOLT -----	[12PCS]				
A10. 5/16"x1 1/2" ROUND BOLT -----	[1PCS]				
A11. 7/16"x1 1/2" ROUND BOLT -----	[1PCS]				
A12. 5/8" ROUND BOLT -----	[1PCS]				
A13. 5/16"x3/8" SET SCREW -----	[3PCS]				
A14. PIN -----	[1PCS]				
A15. Ø1/2"x8.5X21.5 SLEEVE -----	[1PCS]				
A16. STEEL CHAIN -----	[1PCS]				
B1. 1/2" NYLON LOCK NUT -----	[27PCS]				
B2. 3/8" NYLON LOCK NUT -----	[20PCS]				
B3. 5/16" NYLON LOCK NUT -----	[5PCS]				
B4. 5/8" NUT -----	[1PCS]				
B5. 5/16" NUT -----	[2PCS]				
C1. 1/2" (I.D) WASHER -----	[12PCS]				
C2. 3/8" (I.D) WASHER -----	[5PCS]				
C3. 5/16" (I.D) WASHER -----	[13PCS]				
C4. 5/16" SPRING WASHER -----	[12PCS]				
C5. 5/8" SPRING WASHER -----	[1PCS]				
C6. 1/2" ROUND END CAP WASHER -----	[2PCS]				

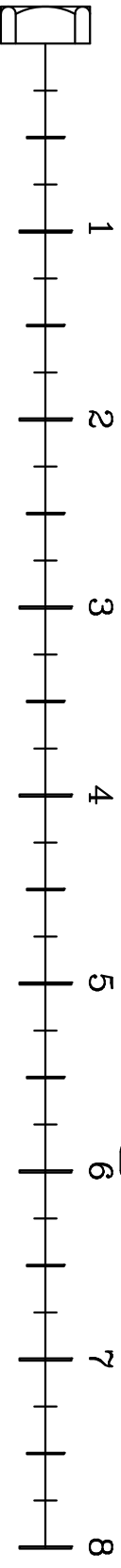

EXM-2800.2 HARDWARE ILLUSTRATION SHEET

D1.	2"x4" END CAP (9211-014) -----	Qty.
D2.	75X75 END CAP (9211-007) -----	[3PCS]
D3.	50X75 END CAP (9211-012) -----	[11PCS]
D4.	2"x2"x2.5t END CAP (9211-006) -----	[5PCS]
D5.	2"x2" END CAP (9211-005) -----	[1PCS]
D6.	1 3/4"x1 3/4" END CAP (9211-004) -----	[4PCS]
D7.	1"x2" END CAP (9211-009) -----	[2PCS]
D8.	20X40 END CAP (9211-008) -----	[8PCS]
D9.	ø1" ROUND END CAP (9211-016) -----	[2PCS]
D10.	ø1" ROUND END CAP (8341-033) -----	[8PCS]
D11.	60X50 NYLON BUSHING (9211-033) -----	[4PCS]
D12.	60X45 NYLON BUSHING (9211-032) -----	[2PCS]
D13.	ø10.5 STEEL BUSHING (8530-009) -----	[10PCS]
D14.	ø3/4"x8L STEEL BUSHING (8110-014) -----	[2PCS]
D15.	ø2 1/2" RUBBER DOUNT (9310-010) -----	[2PCS]
D16.	2"x2" RUBBER DOUNT (9310-020) -----	[1PCS]
D17.	ø3" NYLON WASHER (9214-008) -----	[8PCS]
D18.	ø38 CU WASHER (8520-008) -----	[2PCS]
D19.	ø1"x135L RUBBER GRIP (9212-017) -----	[8PCS]
D20.	6" RUBBER GRIP (9212-016) -----	[2PCS]
D21.	ø110 PULLEY (9213-002) -----	[20PCS]
D22.	TOP PLATE (8400-004) -----	[1PCS]
D23.	PULLEY WHEEL BLOCK (8331-017) -----	[5PCS]
D24.	ø8 SPRING SNAP LINK (8810-001) -----	[5PCS]
D25.	LATEX (9310-022) -----	[2PCS]
D26.	110 BALL PIN (8250-017) -----	[1PCS]
D27.	WEIGHT SELECTOR BAR (8220-060) -----	[1PCS]
D29.	4"x23X8" FOAM ROLLER (9161-009) -----	[8PCS]
D30.	ø1/2" PIN (8240-023) -----	[1PCS]
D31.	RUBBER GRIP (9162-004) -----	[2PCS]
D32.	1595mm STEEL CABLE -----	[1PCS]
D33.	3330mm STEEL CABLE -----	[1PCS]
D34.	3285mm STEEL CABLE -----	[1PCS]
D35.	1410mm STEEL CABLE -----	[1PCS]

D36.	2135mm STEEL CABLE -----	Qty.
D37.	3400mm STEEL CABLE -----	[1PCS]
D38.	ROUND END CAP -----	[4PCS]
D39.	ø1" ROUND END CAP (9211-021) -----	[2PCS]
D40.	95X140mm NO SLIP TAPEL (9310-035) -----	[2PCS]
D41.	ø3/4" SHAFT COLLAR (9211-046) -----	[2PCS]

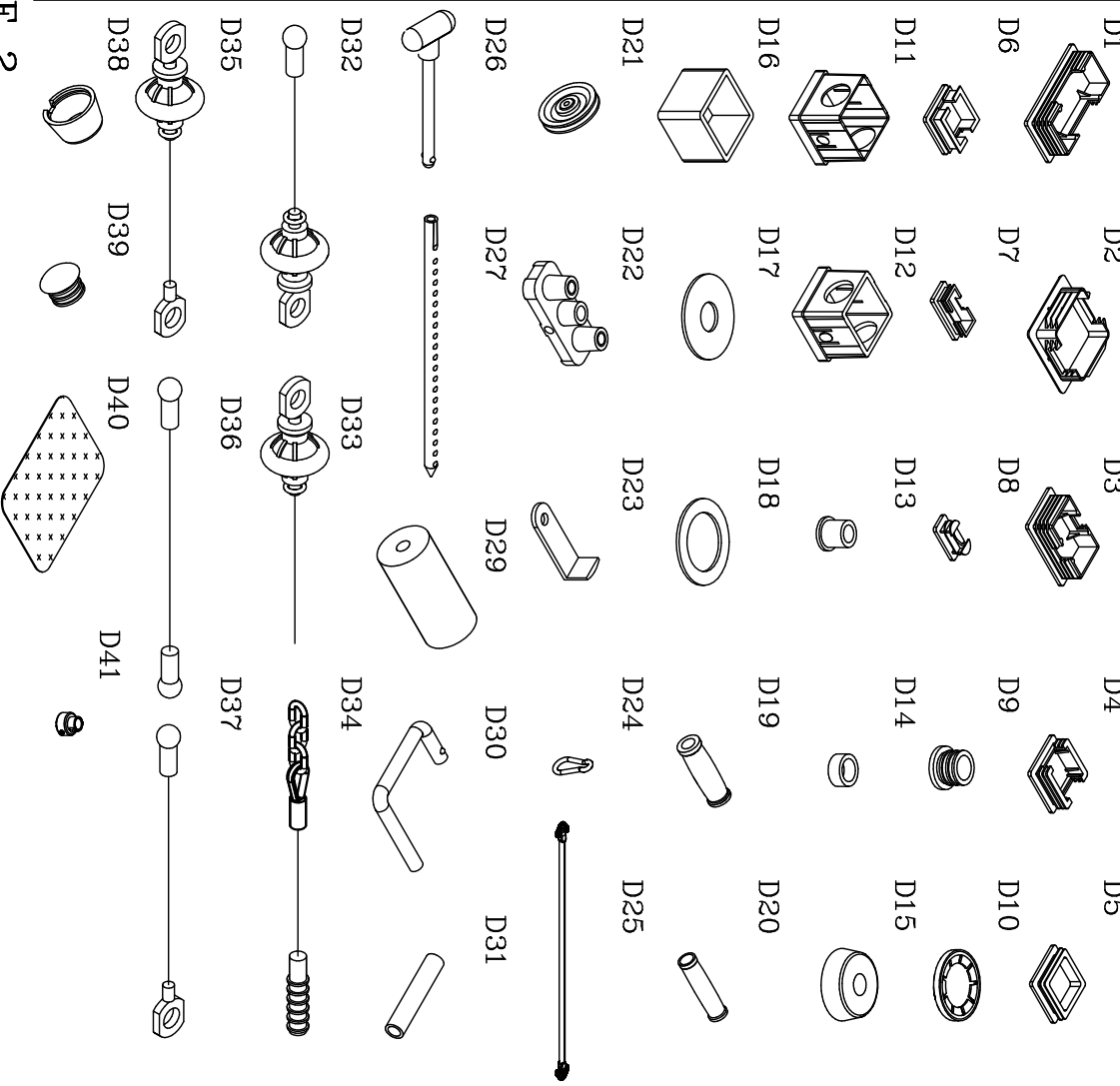

A [1PCS]

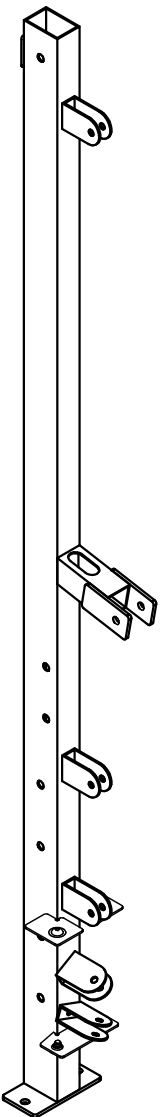

B [1PCS]

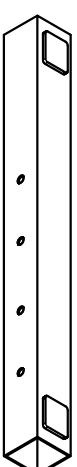

C [1PCS]

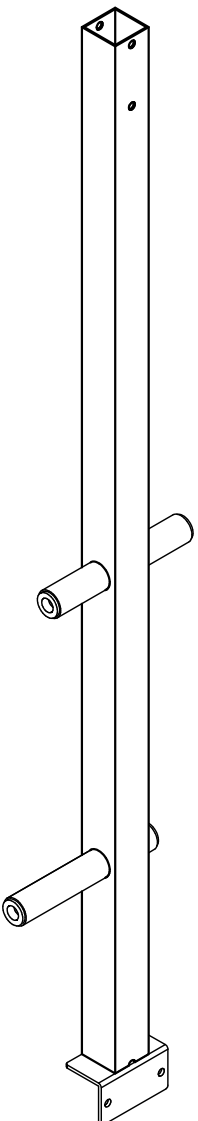

D [1PCS]

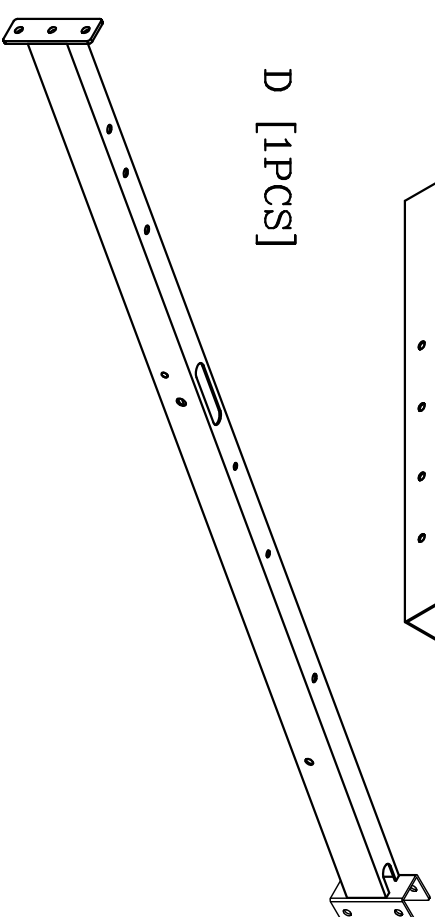

E [1PCS]

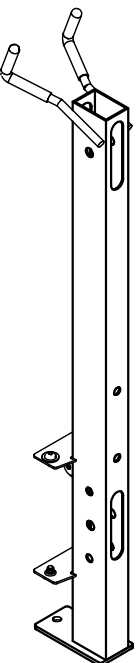

F [1PCS]

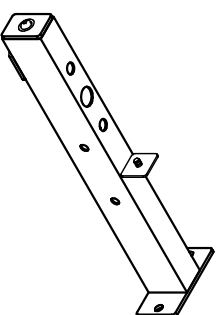

G [1PCS]

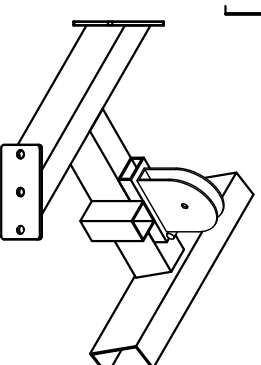

H [1PCS]

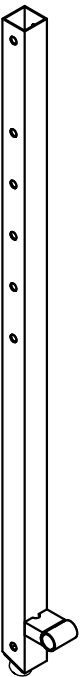

I [1PCS]

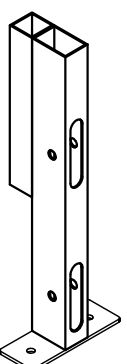

J [1PCS]

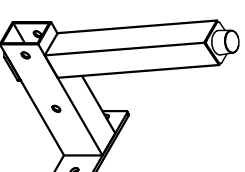

K [1PCS]

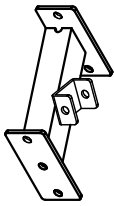

L [1PCS]

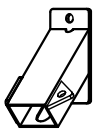

M [1PCS]

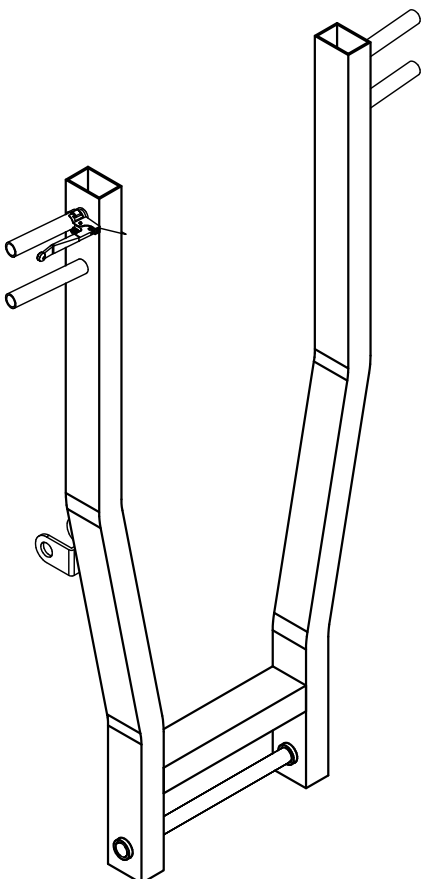

N [1PCS]

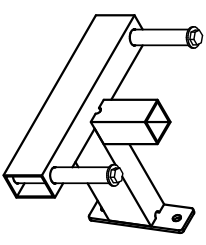

O [1PCS]

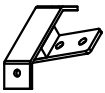

P [1PCS]

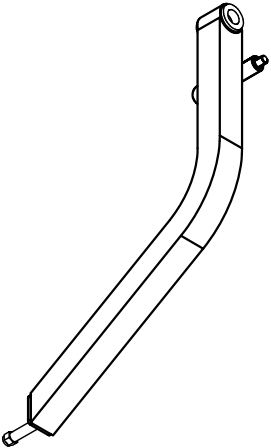

Q [1PCS]

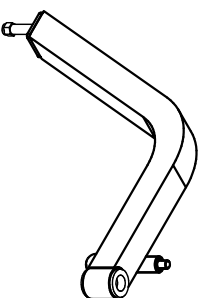

R [1PCS]

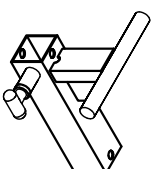

S [2PCS]

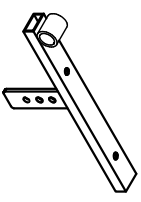

T [1PCS]

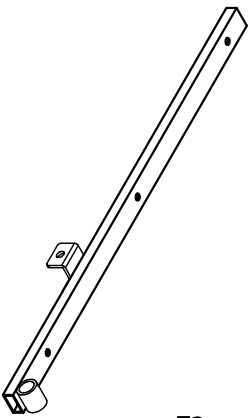

T1 [1PCS]

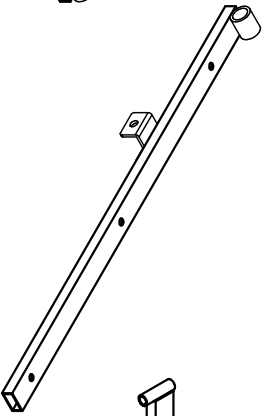

U [2PCS]

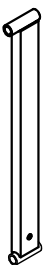

V [1PCS]

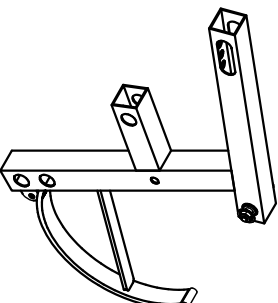







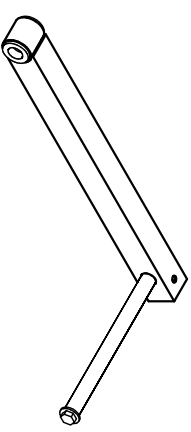

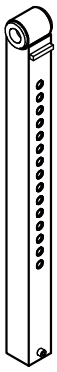
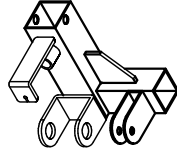



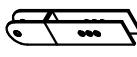



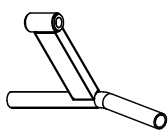
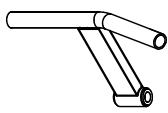



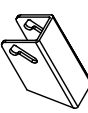

W [1PCS]



X [1PCS]

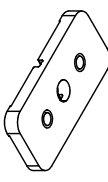
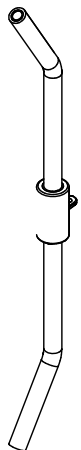

Y [1PCS]	Z [1PCS]	AA [1PCS]	AB [1PCS]	AC [1PCS]	AD [1PCS]
					
AE [2PCS]	AF [2PCS]	AG [2PCS]	AH [1PCS]	AI [1PCS]	AJ [2PCS] (D30378)
					
AK [2PCS] (E10158)					
					
AL [1PCS] (E10159)	AM [1PCS] (E10134) (2000mm)	BE [1PCS] (E10064) (1970mm)	AN [1PCS] (D30397)	AO [1PCS] (D30382)	AP [1PCS] (1"X400mm)
					
AQ [1PCS] (E10057)	AR [1PCS] (1"X493mm)	AS [2PCS] (1"X475mm)	AT [20PCS]	AU [1PCS]	AV [1PCS]
					

AW [1PCS]

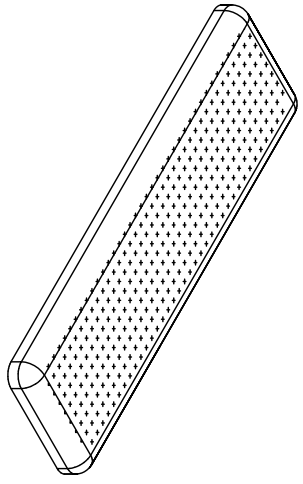

AX [1PCS]

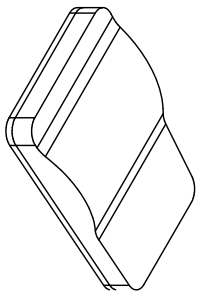

AY [1PCS]

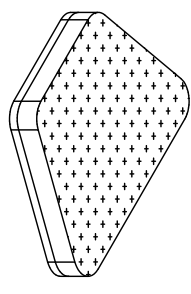

AZ [1PCS]

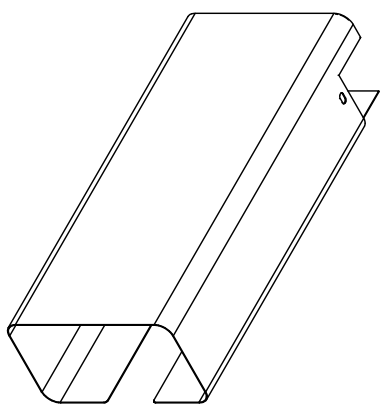

BA [1PCS]

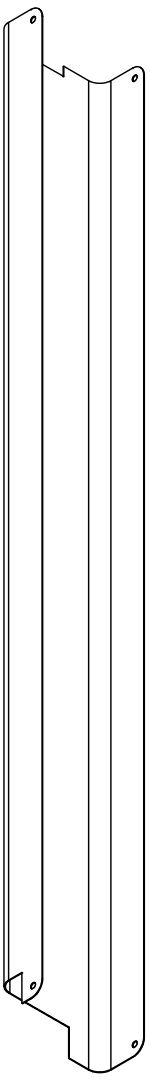

BC [1PCS]

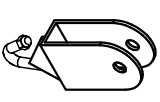

BD [1PCS]



BB [1PCS]

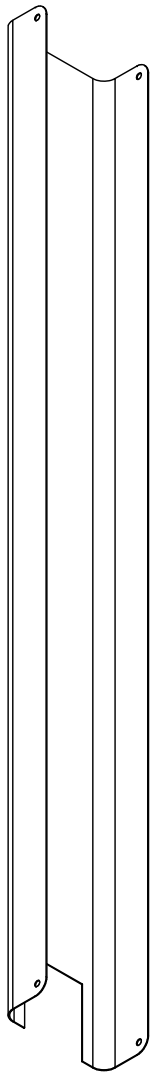

EXM-2800.2

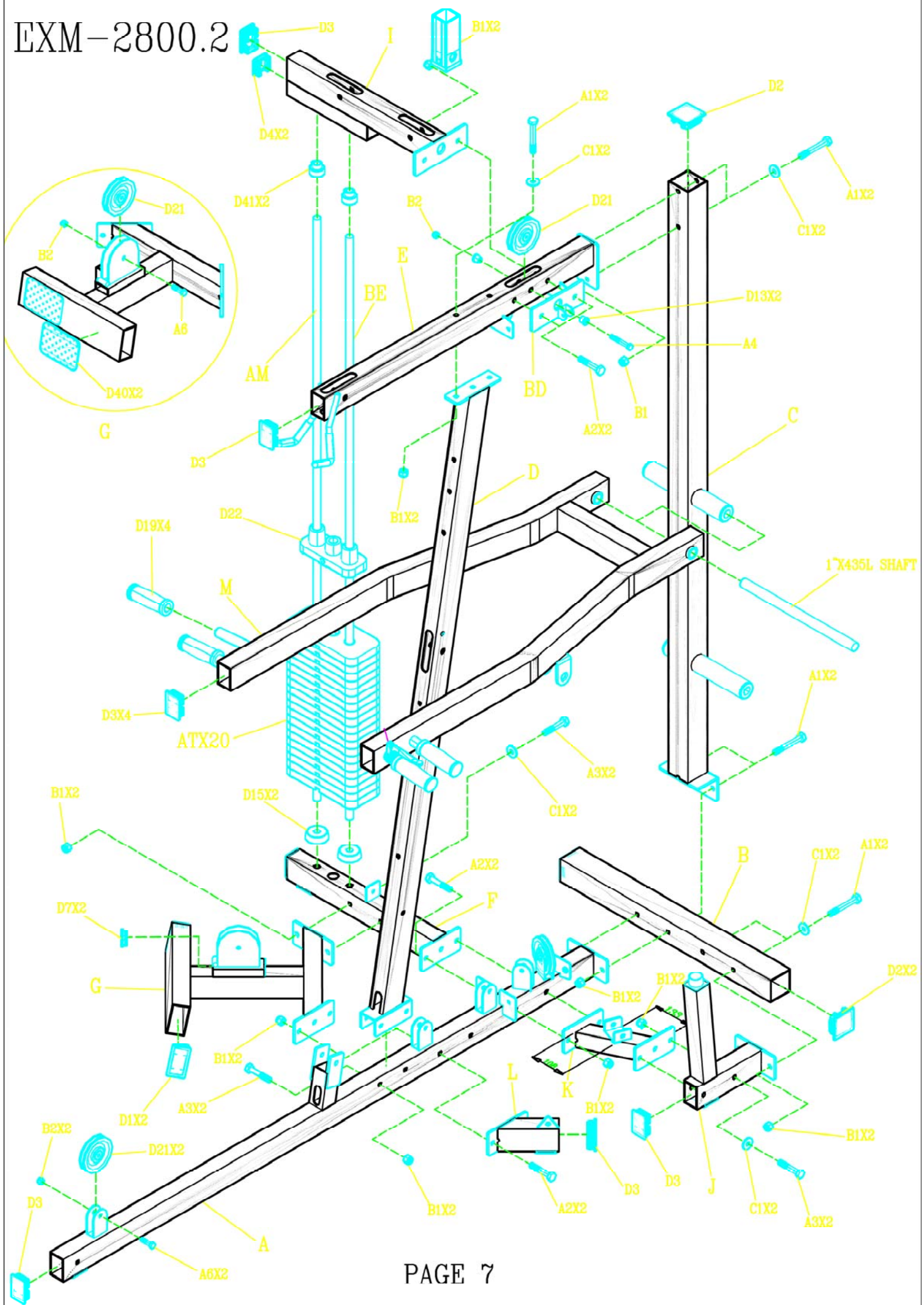

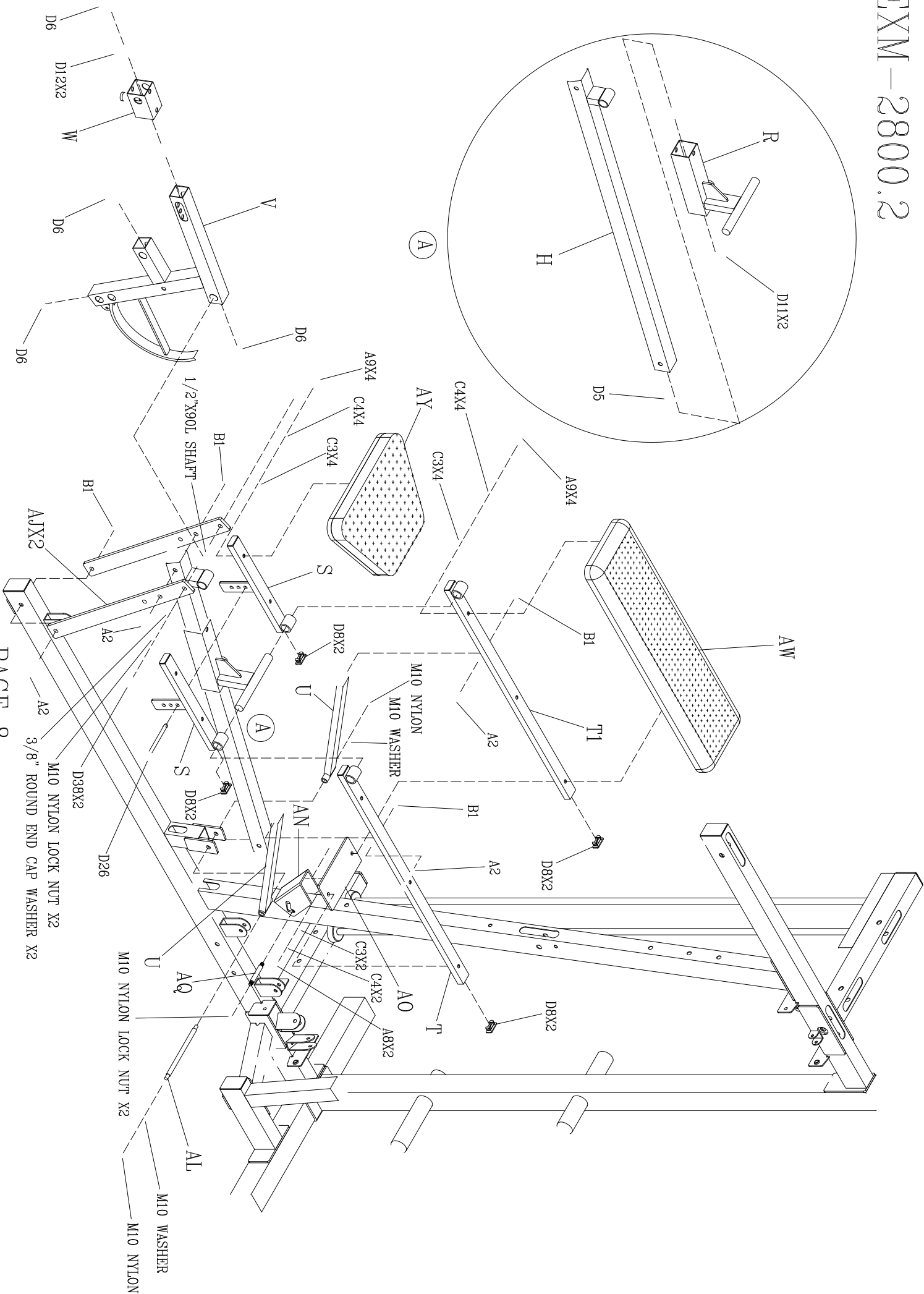

3/8" ROUND END CAP WASHER X2

M10 NYLON LOCK NUT X2
M10 WASHER
M10 NYLON

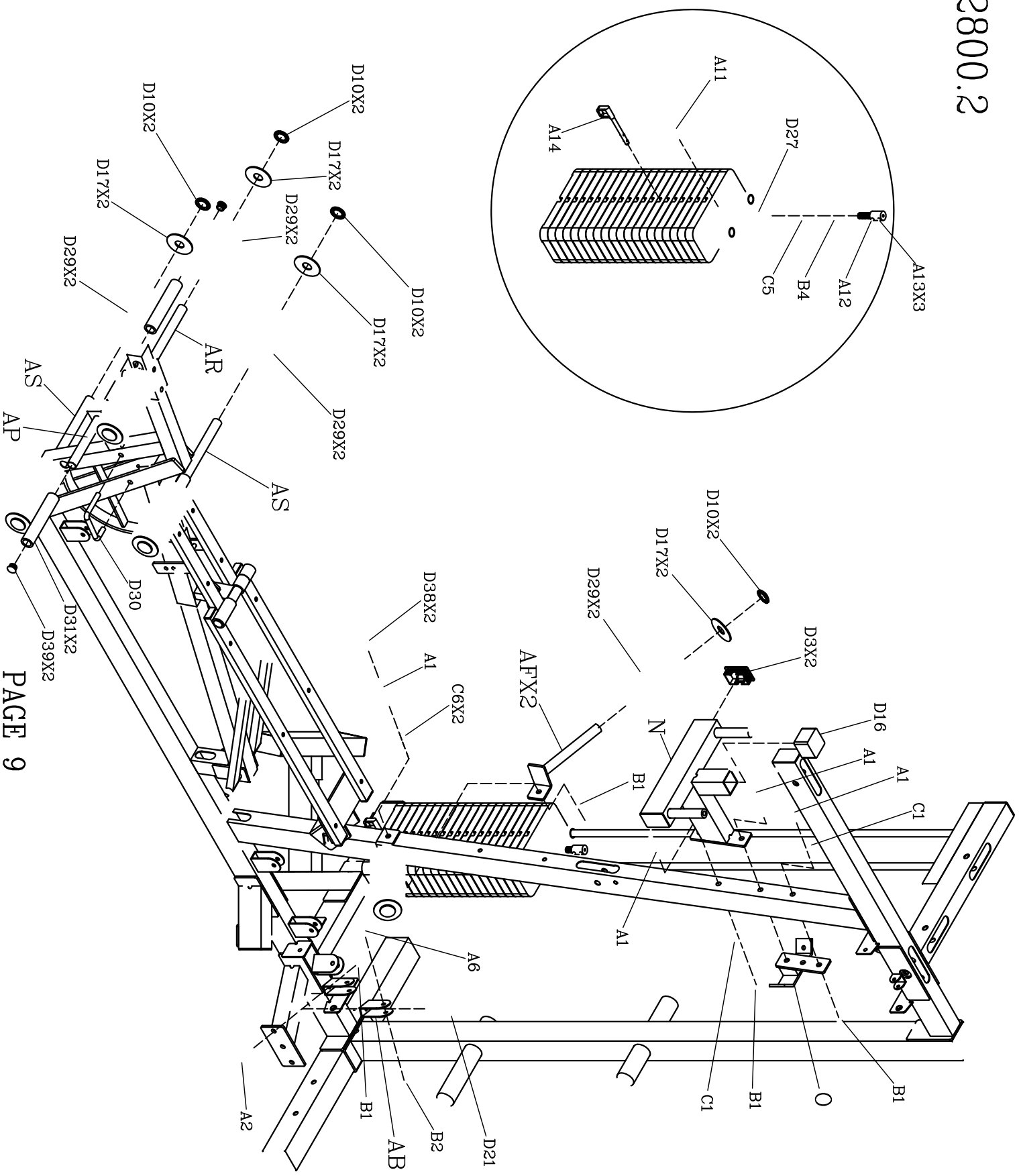

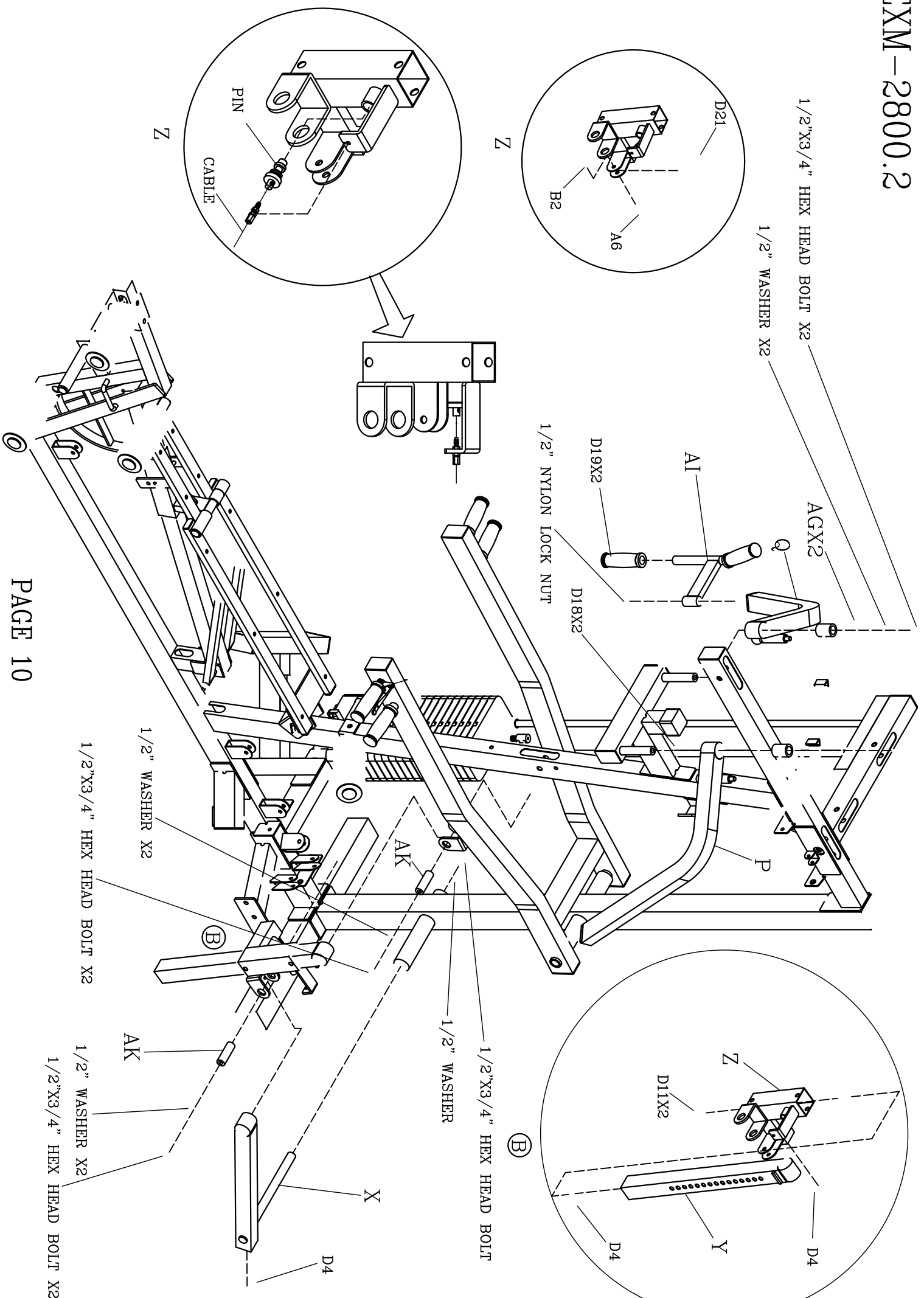

EXM-2800.2

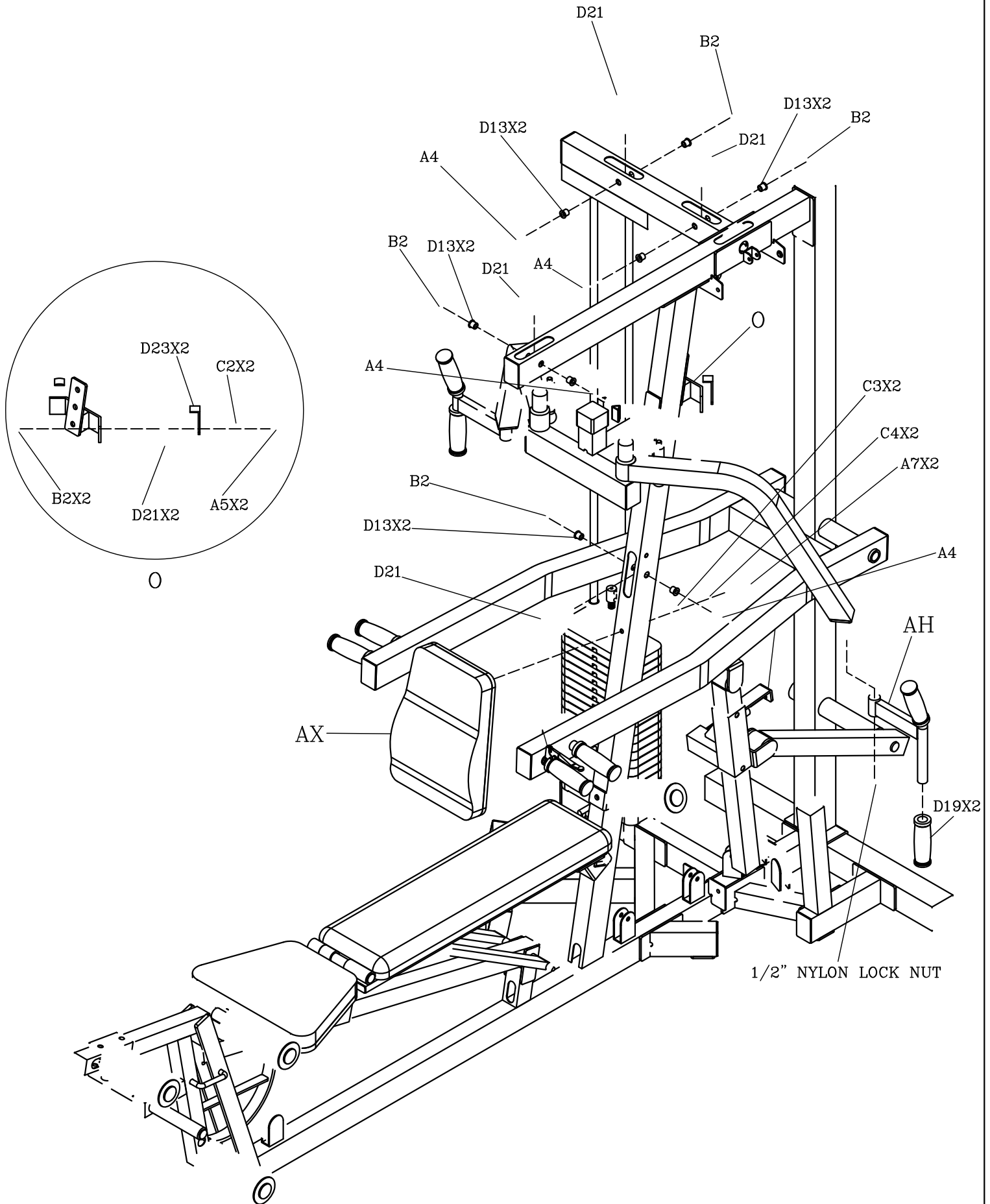

EXM-2800.2

D33

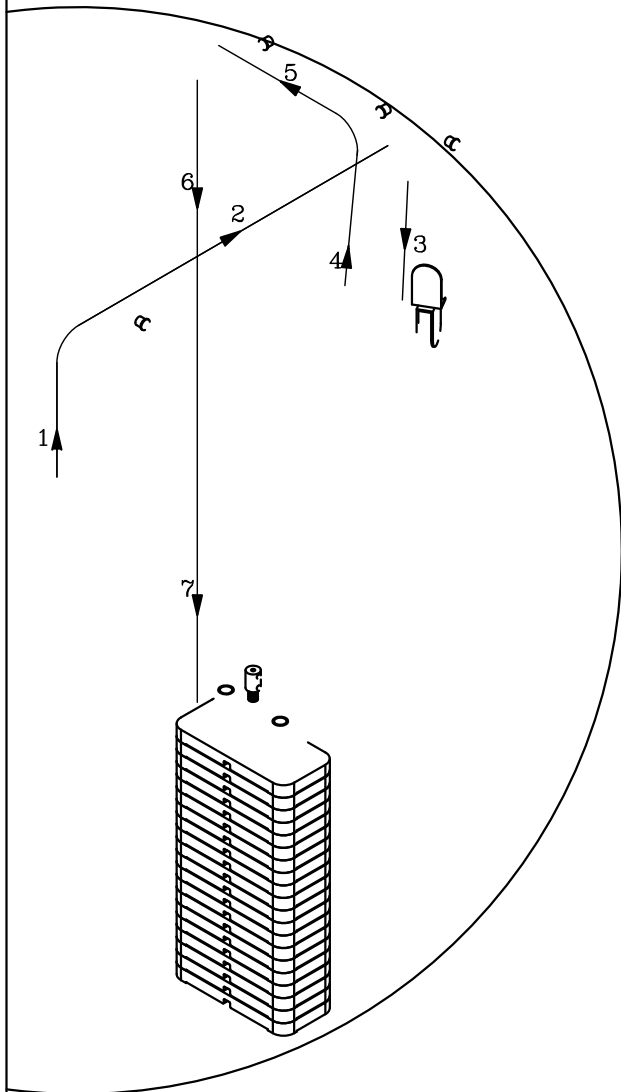

D33

